



# Rear Seat

## Removal/Installation

NOTE: Take care not to scratch the seat covers and body.

### ► Bolt locations

A ►, 1

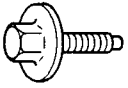

B ►, 3

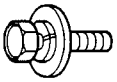

6x 1.0 mm  
9.8 N-m (1.0 kgf-m,  
7.2 lbf-ft)

### ▷ Clip, hook locations

A ►, 2

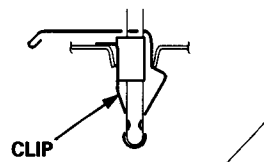
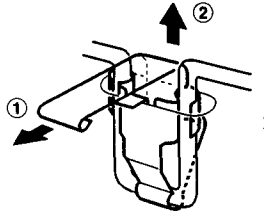

CLIP

B ►, 3

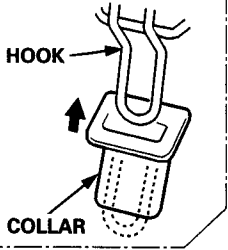

HOOK

COLLAR

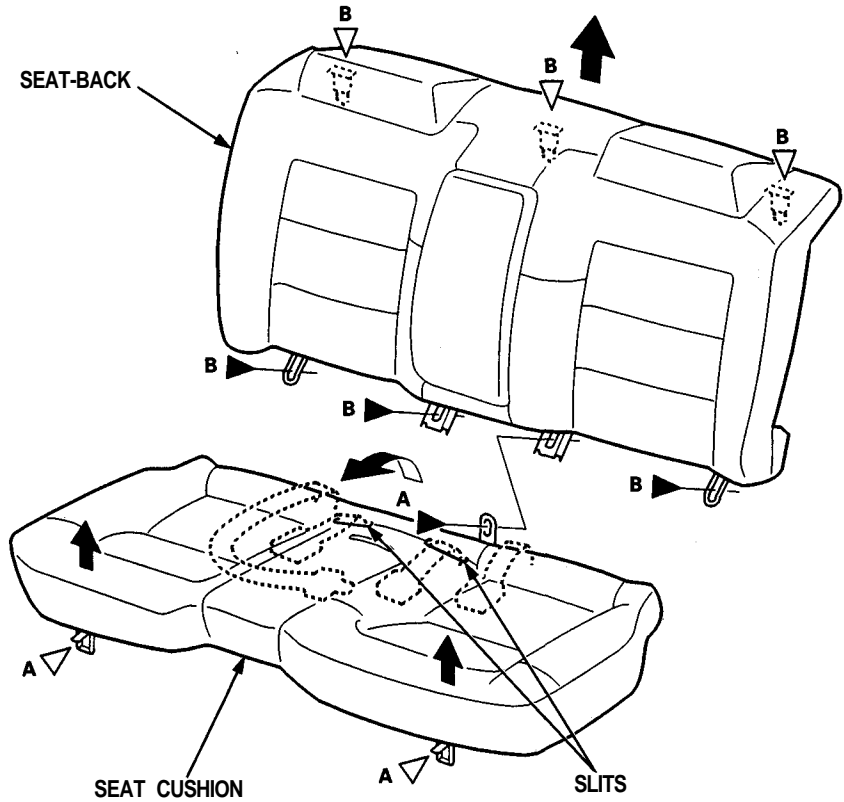

### Armrest removal:

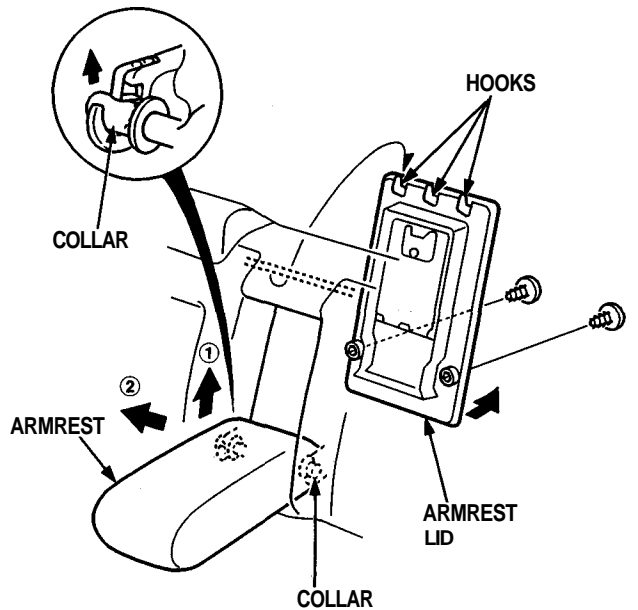

Installation is the reverse of the removal procedure.

### NOTE:

- Before attaching the seat-back and seat cushion, make sure there are no twists or kinks in the rear seat belts and center belt.
- When installing the seat cushion, slip the seat belt buckles through the slits in the seat cushion.